

Square Downlight

DLS-020-AW-W/NW/WW-02

Features:

1. Use die-casting aluminum alloy as main-body material.
2. Use high light transmittance toughened glass as cover material.
3. Unique and beautiful looking design.
4. Good heat dissipation performance guarantee the long life span.
5. Unibody design with main-body and adapter.
6. Use LED driver, high effective and energy-saving.
7. Directly replace Philips traditional downlight MBN200.
8. Can rotate 45 degrees.

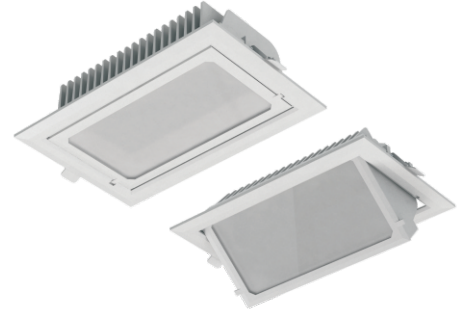

Application:

Hotel room, passage, home decoration, office...



Dimenions(unit:mm):

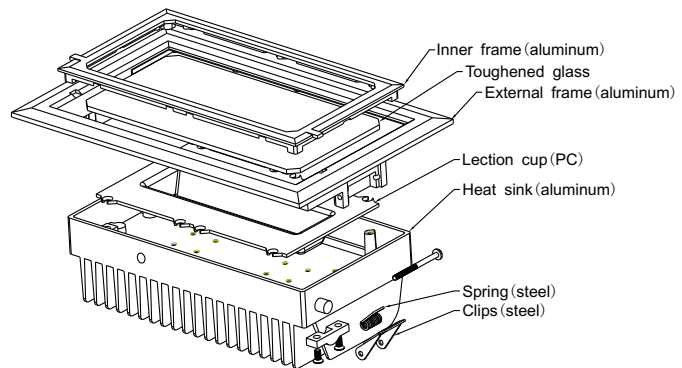
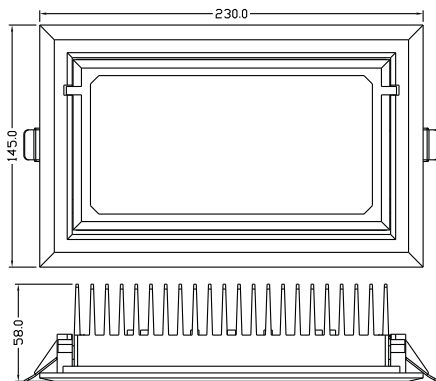

Specification:

Model Number	Color	CCT	LED Type	CRI	Light Output (lm)	Beam angle	Power	Voltage	Max. Current	PF	Net Weight	Gross Weight
DLS-020-AW-W-02	White	5500-7000K	SMD 5730 42 pcs	>80	1650	80°	20W	100-240V AC 50/60Hz	0.2A	≥0.9	1.3Kg	1.5Kg
DLS-020-AW-WW-02	Warm white	2700-3200K	SMD 5730 42 pcs	>80	1260	80°	20W	100-240V AC 50/60Hz	0.2A	≥0.9	1.3Kg	1.5Kg
DLS-020-AW-NW-02	Natural White	4000-4500K	SMD 5730 42 pcs	>80	1600	80°	20W	100-240V AC 50/60Hz	0.2A	≥0.9	1.3Kg	1.5Kg

Packing information:

Inner box dimension: 325*170*85 mm

Outer carton dimension: 685*375*305 mm (12 boxes per carton)

Carton gross weight: 19.5Kg

Note: Use no-logo package.

Installation drawing

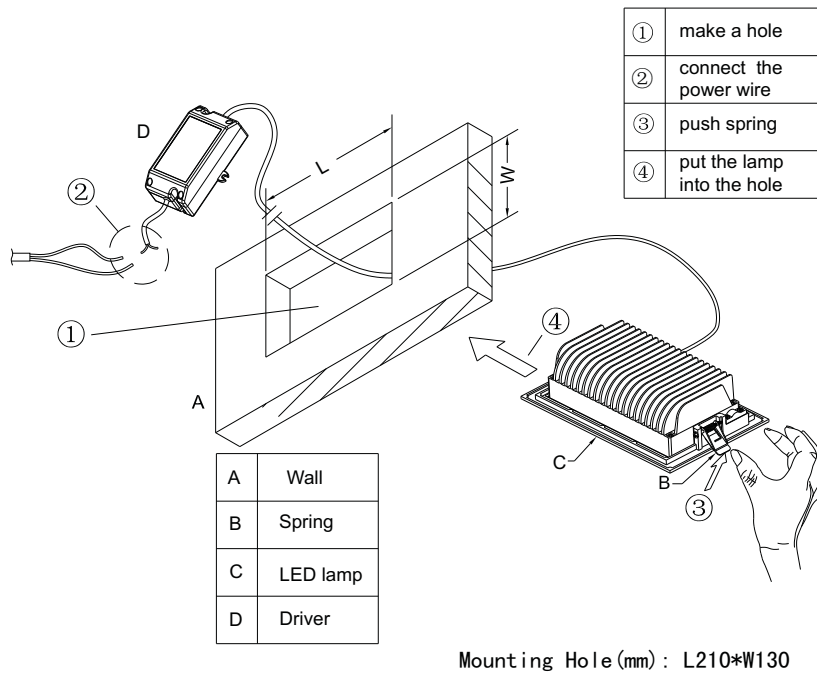

Installation information:

Power must be cut off before installation, fix it on the position of installation holes, connection of the power supply must be sealed.

! Notice

1. Please read the specification first, to make sure the service environment matches the condition in the specification before using.
2. Please confirm the applicable power supply before using.
3. Make sure the switch of product is off before connect to the power supply to prevent electric shock.
4. Operation against rules may damage your property even harm to your personal safety.
5. Preliminarily estimate required quantity of LED lights, then according to the power rating of single LED light to figure out the total power and design power supply plan.
6. Cannot be installed on pipe or tube.
7. Using environment: -20°C to 45°C.
8. Dangerous high voltage, Non-professionals are not allowed to maintain the products.
9. If the exterior flexible cable or wire is damaged, it must exchange by the supplier, its agent or other similar qualified personnels to avoid dangers.

